

systemceram

KeraDomo-Küchenkeramik

www.systemceram.de

## KERADOMO PROGRAMI



FİYAT LİSTESİ 2025-1

Made in Germany! Tüm eviyeler 5 yıl garantilidir.



**KeraDomo**

**LABORATUVAR MALZEMESİ KALİTESİ**

YÜKSEK MALZEME YOĞUNLUĞU  
DİRENÇİ SAĞLAMAKTADIR

HASSAS SERAMİK

Systemceram, LABORATUVAR MALZEMESİ için belirli STANDART GEREKSİNİMLERİNİ KARŞILAYACAK PORSELEN ÜRETİMİ konusunda uzmanlaşmış bir firmadır. YÜKSEK KALİTE MALZEMELER, YÜKSEK DİRENÇ ÖZELLİKLERİNİ ve UZUN YILLAR SÜRECEK KULLANIMI garanti etmektedir.



**NEW!**

## İÇERİK

Sayfa

BAKIM ÖNERİLERİ, KERADOMO PROGRAMI, ÜRÜN AVANTAJLARI

1-7

ÜSTTEN YERLEŞTİRMELİ EVİYELER

8-9

TEZGAHTAN TAŞMALI EVİYELER VE AKSESUAR

26

TEZGAHA SIFIR KURULUM İÇİN EVİYELER

30

ALTTAN KURULUM İÇİN EVİYELER

48-49

ARMATÜRLER

55-56

AKSESUARLAR VE YEDEK PARÇALAR SATIŞ VE

57

# KERADOMO EVIYE ÜRÜN SERİSİ

## ÜSTTEN YERLEŞTİRMELİ EVİYELER

45 cm kabin için



BELA 78

Sayfa 12

50 cm kabin için



MERA 90

Sayfa 13

60 cm kabin için



MERA 57

Sayfa 15



GENEA100

Sayfa 18



MERA  
100 SL

Sayfa 20



VEGA 100

Sayfa 22

80 cm kabin için



MERA 80

Sayfa 23



MERA  
DOUBLE

Sayfa 24

## ELEMENTS

90 cm kabin için



CENTRA 90

Page 27

## TEZGAHA SIFIR EVİYELER

### 60 cm kabin için



MERA 57 F

Sayfa 40



MERA  
100 SL / F

Sayfa 45

### 80 cm kabin için



MERA 80 F

Sayfa 46

## ALTAN YERLEŞTİRME EVİYELER

### 45 cm base cabinet



MERA 32 U

Page 49

### 60 cm kabin için



MERA 50 U

Sayfa 51



MERA 60 U

Sayfa 52

### 80 cm kabin için



MERA 80 U

Sayfa 53

## KERADOMO MUTFAK EVİYELERİ tüm dirençlere karşı (ısı, asit, darbe)

ideal bir malzeme ile üretilmiştir. Eviyelerde kullanılan seramik, LABORATUVAR tezgahlarında kullanılan seramik ile aynıdır.

Bu sebeple **KERADOMO MUTFAK EVİYELERİ "5 YIL GARANTİLİDİR."**

### ISI ŞOKLARINA DİRENÇ

Fırından çıkartılan ince keramik şoklara dayanıklıdır. Isıdaki değişimlere özellikle yüksek bir direnç göstermektedir.



### ASİDE KARŞI DİRENÇ

Dayanıklı bir şekilde, seramik tüm evsel temizlik kimyasallarına ve hatta „meyve/sebze suları“ gibi renk yoğunluğu bulunan sıvılara karşı koyabilmektedir.



### DARBEME VE ÇARPMAYA DİRENÇLİ

İnce keramik serttir. Ayrıca, darbe ve çarpmalara dirençlidir.



## HIJYENİK

Pürüzsüz seramik yüzeyler üzerinde hiçbirşey uzun süre kalmaz. Bunlar, kolayca temizlenir, tatsız ve kokusuz olup, son derece hijyeniktir.



## KESMEYE KARŞI DİRENÇLİ

KeraDomo mutfak seramiği kesme işleminin uygulanması için son derece mükemmel bir alandır.





**SYSTEMCERAM GMBH & CO UZUN BİR GELENEĞE SAHİP GENÇ BİR FİRMADIR.** Başlangıcı, 1928 yılındaki **KCH-KERAMCHEMIE** tarafından kurulan seramik dökmeçilik departmanına dayanmaktadır. Sonuç olarak, grup tarafından yönetilen firma departmanı değişerek aile tarafından yönetilen **AİLE ŞİRKETİ** halini almıştır.

Teknik beceri kullanılmış ve daha da geliştirilmiştir. Günümüzde, daha çok mutfak ve laboratuvarlar için orta büyüklükte ve son derece ağır yüklere direnç gösterecek ürünlerin üretimine odaklanılmıştır.

Systemceram, laboratuvar tesisleri için uygulanan standart düzenlemelerin yüksek taleplerini karşılamak için özellikle ince keramik üretmektedir. 1240 derecede ısıtılmakta ve özel madde yoğunluğuna sahip olmaktadır.

Aynı kimyasal-tekni keramik için kullanılan yüksek malzeme kalitesi standartlarını kullanarak, ayrıca modern mutfaklar için eviye veya tezgahlar üretilmektedir.

Eviyelerin şekil ve renkleri ile göze çarpan tasarım ve tezgahın tasarımı yüksek modernlikteki işleme teknolojimizi ortaya koymaktadır.

**KeraDomo**  
**LABORATUVAR MALZEMESİ KALİTESİ**  
**YÜKSEK MALZEME YOĞUNLUĞU**  
**DİRENCİ SAĞLAMAKTADIR**  
**HASSAS SERAMİK**





**MUTFAĞI GÜNLÜK HAYATIN MERKEZİ** olarak gören insanların ihtiyaçlarına cevap vermek için geniş bir ürün gamı meydana getirdik. **FONKSİYONEL ÇEŞİTLİLİK VE ESTETİK** üzerine konsantre olduk. Her bir ürün **DETAYLARA VERİLEN ÖNEM** ile üretilmekte ve **YÜKSEK KALİTE SERAMİKTEN MEYDANA GELMEKTEDİR.**

Tüm modellere ait kalıplarımız kendi atölyemizde teker teker üretilmektedir. Kalıp daha sonra Döküm departmanında sıvı ham malzeme ile doldurulmaktadır. Ham malzemenin sertleşmesi yaklaşık 24 saati bulmaktadır. Kalıbın çıkartılmasından sonra, her bir ürün teker teker kontrol edilmekte ve kurumadan önce parlatılmakta, sırlanmakta ve fırınlanmaktadır. Boyama uygulaması, bilgisayar-kontrollü sırlama kabinlerinde dakika-ayarlı olarak yürütülmektedir.

Özel eğitilmiş seramik sırlama uzmanları özel sırlama işlemi için çalışmaktadır. Ateş tuğlasının tersine, hassas seramik daha yüksek malzeme yoğunluğuna sahiptir.

Eviyeler sonrasında ilgili kesim ölçülerine göre programlanmış TAŞLAMA robotu sayesinde ebatlarına uygun hale getirilir. Burada da, son kontroller el yardımı ile yapılmakta ve sonrasında ürünlere son dokunuşlar yapılmaktadır.



MODEL ATÖLYESİ



KALIBA DÖKME



ÇİLALAMA/PARLATMA

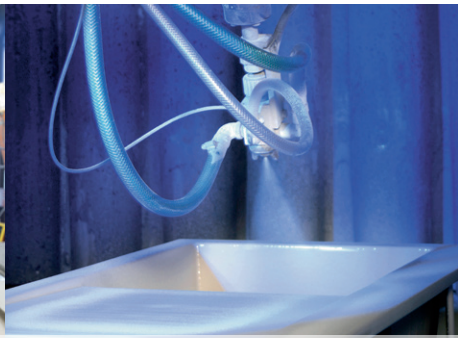

SIRLAMA

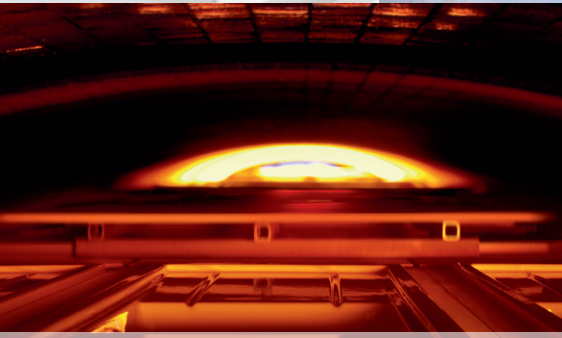

FIRINLAMA



TAŞLAMA



SON KONTROL



**BELA 78** 45 cm enindeki kabinler için - üstten yerleştirmeli eviye

Standart renkler



Alu 76

## Ölçüler / Yerleştirme çizimleri

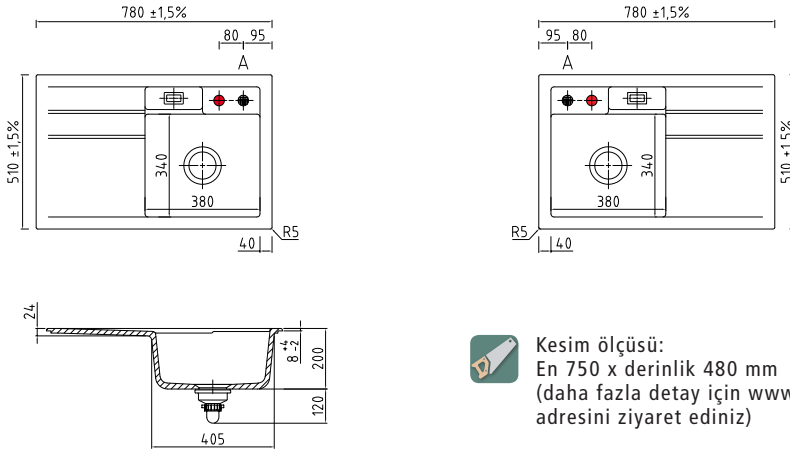

Kesim ölçüsü:  
En 750 x derinlik 480 mm  
(daha fazla detay için [www.systemceram.de](http://www.systemceram.de)  
adresini ziyaret ediniz)

**Dikkat:Entegre Bulaşık makinesi  
durumunda min. tezgah kalınlığı 20 mm.**

● Armatür deliği vardır. Önceden kırılmaya hazır kırılma noktaları yoktur. Kişisel isteğe göre delik açılır.  
⊕ A noktası, lütfen çizime bakınız). Ø ~ 35 mm.

KERADOMO BELA 78	Ürün No.	Standart renkler	Özel renkler
	Sol hazne		
Otomatik gider ile, paslanmaz çelik yuvarlak kumanda, Ø 45 mm	5019 02 76	29.950.00 TL	

Dikkat, lütfen renk numarasını belirtiniz.

## Özel aksesuarlar

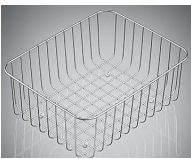

**Sepet**  
paslanmaz çelik  
Ürün No. 0760  
4.250.00 TL

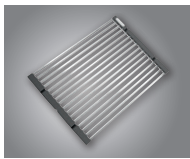

**Katlanabilir ızgara/  
Rollmat**  
paslanmaz çelik  
310 x 450 mm  
Ürün No. 0841  
6.070.00 TL

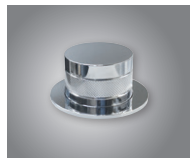

**Gömülebilir kumanda**  
Ürün No. 0872  
krom 3.920.00 TL  
Ürün No. 0871  
paslanmaz çelik  
4.230.00 TL

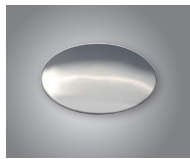

**Gider kapağı**  
paslanmaz çelik  
Ürün No. 0901  
parlak 1.690.00 TL  
Ürün No. 0902  
satine 1.850.00 TL



**Sıvı sabunluk**  
Ürün No. 0903  
krom 11.460.00 TL  
Ürün No. 0904  
paslanmaz çelik  
12.230.00 TL

## MERA 90 50 cm enindeki kabinler için - üstten yerleştirmeli eviye



### Standart renkler



Grönland 12  
glossy



Polar 13



Siena 65



Nero 68  
glossy



Alu 76

### Ölçüler / Yerleştirme çizimleri

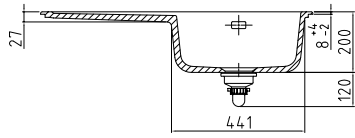
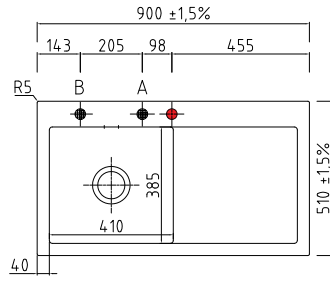
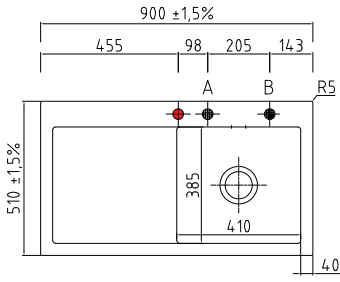

Kesim ölçüsü:  
En 870 x derinlik 480 mm  
(daha fazla detay için [www.systemceram.de](http://www.systemceram.de)  
adresini ziyaret ediniz)

**Dikkat:Entegre Bulaşık makinesi  
durumunda min. tezgah kalınlığı 30 mm.**

● Armatür deliği vardır. Önceden kırılmaya hazır kırılma noktaları yoktur. Kişisel isteğe göre delik açılır.  
(● A ve B noktası, lütfen çizime bakınız). Ø ~ 35 mm.

KERADOMO MERA 90	Ürün No.	Standart renkler	Özel renkler
	Sağ hazne/Sol hazne		
Manuel gider ile	5074 01/5075 01	47.300.00 TL	53.770.00 TL
Otomatik gider ile, paslanmaz çelik yuvarlak kumanda, Ø 45 mm	5074 02/5075 02	53.770.00 TL	58.400.00 TL

### Özel renkler



Magnolie 10  
glossy



Jasmin 19



Fango 23



Titan 78



Lava 80



Schiefer 85



Nigra 87

Dikkat, lütfen renk numarasını belirtiniz.

### Özel aksesuarlar



Derin Süzgeç  
paslanmaz çelik  
Ürün No. 0831  
12.690.00 TL



Sepet  
paslanmaz çelik  
Ürün No. 0730  
7.150.00 TL



Kesme tahtası  
cam  
Ürün No. 0735  
7.150.00 TL

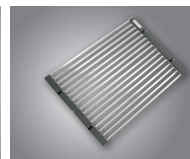

Katlanabilir ızgara/  
Rollmat  
paslanmaz çelik  
310 x 450 mm  
Ürün No. 0841  
6.070.00 TL

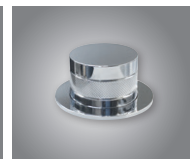

Gömülebilir kumanda  
Ürün No. 0872  
krom 3.920.00 TL  
Ürün No. 0871  
paslanmaz çelik  
4.230.00 TL



Gider kapağı  
paslanmaz çelik  
Ürün No. 0901  
parlak 1.690.00 TL  
Ürün No. 0902  
satine 1.850.00 TL



Sıvı sabunluk  
Ürün No. 0903  
krom 11.460.00 TL  
Ürün No. 0904  
paslanmaz çelik  
12.230.00 TL

## MERA 57 60 cm enindeki kabinler için - üstten yerleştirmeli eviye



### Standart renkler



Grönland 12  
glossy



Polar 13



Siena 65



Nero 68  
glossy



Alu 76

### Ölçüler / Yerleştirme çizimleri

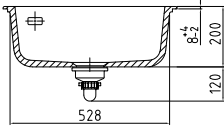
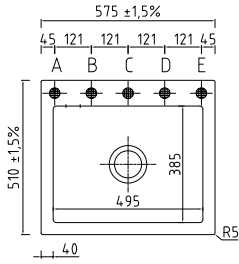

Kesim ölçüsü:  
En 545 x derinlik 480 mm  
(daha fazla detay için [www.systemceram.de](http://www.systemceram.de)  
adresini ziyaret ediniz)

Armatür deliği ve önceden kırılmaya hazır kırılma noktaları yoktur. Kişisel isteğe göre delik açılır.  
(● A, B, C, D ve E noktası, lütfen çizime bakınız). Ø ~ 35 mm.

### Özel renkler



Magnolie 10  
glossy



Jasmin 19



Fango 23



Titan 78



Lava 80



Schiefer 85



Nigra 87

Dikkat, lütfen renk numarasını belirtiniz.

KERADOMO MERA 57	Ürün No.	Standart renkler	Özel renkler
Manuel gider ile	5057 01	42.300.00 TL	46.950.00 TL
Otomatik gider ile, paslanmaz çelik yuvarlak kumanda, Ø 45 mm	5057 02	46.950.00 TL	51.500.00 TL

### Özel aksesuarlar



Derin süzgeç  
paslanmaz çelik  
Ürün No. 0831  
12.690.00 TL

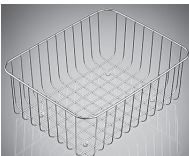

Sepet  
paslanmaz çelik  
Ürün No. 0722  
7.385.00 TL



Kesme tahtası  
cam  
Ürün No. 0735  
7.150.00 TL

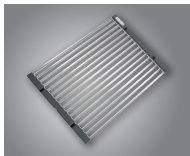

Katlanabilir ızgara/  
Rollmat  
paslanmaz çelik  
310 x 450 mm  
Ürün No. 0841  
6.070.00 TL

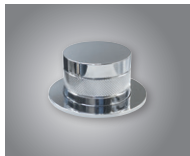

Gömülebilir kumanda  
Ürün No. 0872  
krom 3.920.00 TL  
Ürün No. 0871  
paslanmaz çelik  
4.230.00 TL



Gider kapağı  
paslanmaz çelik  
Ürün No. 0901  
parlak 1.690.00 TL  
Ürün No. 0902  
satine 1.850.00 TL



Sıvı sabunluk  
Ürün No. 0903  
krom 11.460.00 TL  
Ürün No. 0904  
paslanmaz çelik  
12.230.00 TL

# GENEA 100 60 cm enindeki kabinler için - üstten yerleştirmeli eviye



## Standart Renkler



Grönland 12  
glossy



Polar 13



Siena 65



Nero 68  
glossy



Alu 76

## Ölçüler / Yerleştirme çizimleri

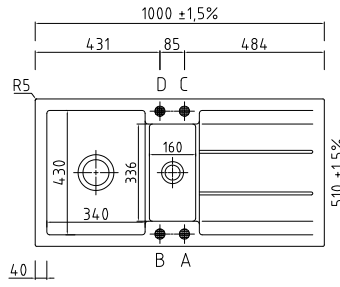
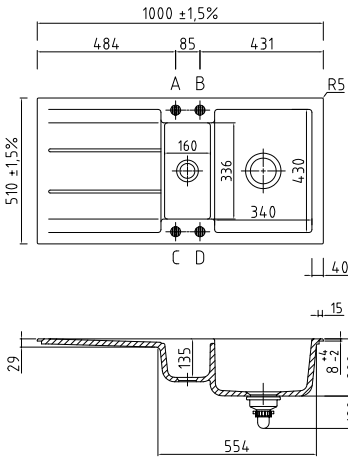

Kesim ölçüsü:  
En 970 x derinlik 480 mm  
(daha fazla detay için [www.systemceram.de](http://www.systemceram.de)  
adresini ziyaret ediniz)

Kapatılmaz eviye gideri

**Dikkat:Entegre Bulaşık makinesi  
durumunda min. tezgah kalınlığı 30 mm.**

Armatür deliği yoktur. Önceden kırılmaya hazır kırılma noktaları yoktur. Kişisel isteğe göre delik açılır. (A, B, C ve D noktası, lütfen çizime bakınız). Ø ~ 35 mm.

## Özel renkler



Magnolie 10  
glossy



Jasmin 19



Fango 23



Titan 78



Lava 80



Schiefer 85



Nigra 87

Dikkat, lütfen renk numarasını belirtiniz.

KERADOMO GENEA 100	Ürün No.	Standart renkler	Özel renkler
	çevirilebilir		
Manuel gider ile	5092 01	58.750.00 TL	65.300.00 TL
Otomatik gider ile, paslanmaz çelik yuvarlak kumanda, Ø 45 mm	5092 02	65.300.00 TL	71.850.00 TL

## Özel aksesuarlar



**Sığ süzgeç**  
1/3 delikli  
paslanmaz çelik  
Ürün No. 0836  
2.700.00 TL

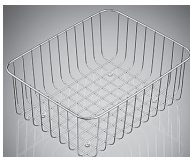

**Sepet**  
paslanmaz çelik  
Ürün No. 0610  
5.920.00 TL

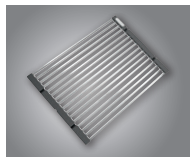

**Katlanabilir ızgara/  
Rollmat**  
paslanmaz çelik  
310 x 450 mm  
Ürün No. 0841  
6.070.00 TL

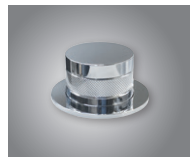

**Gömülebilir kumanda**  
Ürün No. 0872  
krom 3.920.00 TL  
Ürün No. 0871  
paslanmaz çelik  
4.230.00 TL



**Gider kapağı**  
paslanmaz çelik  
Ürün No. 0901  
parlak 1.690.00 TL  
Ürün No. 0902  
satine 1.850.00 TL



**Sıvı sabunluk**  
Ürün No. 0903  
krom 11.460.00 TL  
Ürün No. 0904  
paslanmaz çelik  
12.230.00 TL

## MERA 100 SL 60 cm enindeki kabinler için - üstten yerleştirmeli eviye



### Standart Renkler



Grönland 12  
glossy



Polar 13



Siena 65



Nero 68  
glossy



Alu 76

### Özel Renkler



Magnolie 10  
glossy



Jasmin 19



Fango 23



Titan 78



Lava 80



Schiefer 85



Nigra 87

Dikkat, lütfen renk numarasını belirtiniz.

### Ölçüler / Yerleştirme çizimleri

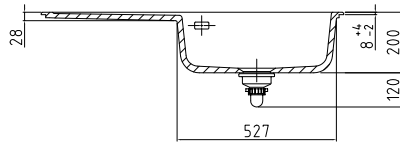
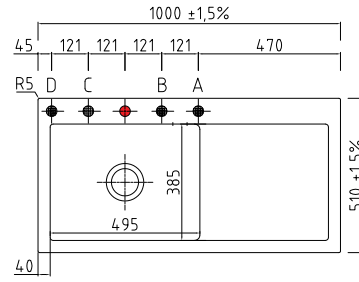
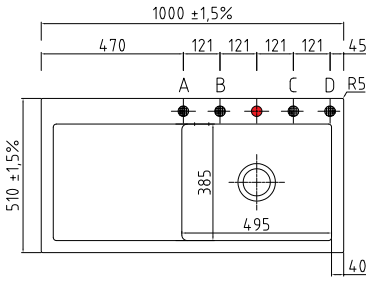

Kesim ölçüsü:

En 970 x derinlik 480 mm  
(daha fazla detay için [www.systemceram.de](http://www.systemceram.de)  
adresini ziyaret ediniz)

**Dikkat:Entegre Bulaşık makinesi  
durumunda min. tezgah kalınlığı 20 mm.**

● Armatür deliği vardır. Önceden kırılmaya hazır kırılma noktaları yoktur. Kişisel isteğe göre delik açılır.  
(● A, B, C ve D noktası, lütfen çizime bakınız). Ø ~ 35 mm.

KERADOMO MERA 100 SL	Ürün No.	Standart Renkler	Özel Renkler
	Sağ hazne/Sol hazne		
Manuel gider ile	5064 01 / 5065 01	58.850.00 TL	65.770.00 TL
Otomatik gider ile, paslanmaz çelik yuvarlak kumanda, Ø 45 mm	5064 02 / 5065 02	65.770.00 TL	72.750.00 TL

### Özel aksesuarlar



Derin süzgeç  
paslanmaz çelik  
Ürün No. 0831  
12.690.00 TL

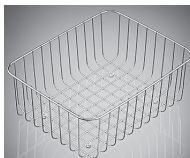

Sepet  
paslanmaz çelik  
Ürün No. 0722  
7.385.00 TL



Kesme tahtası  
cam  
Ürün No. 0735  
7.150.00 TL

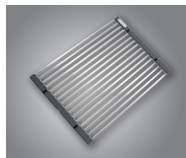

Katlanabilir ızgara/  
Rollmat  
paslanmaz çelik  
310 x 450 mm  
Ürün No. 0841  
6.070.00 TL

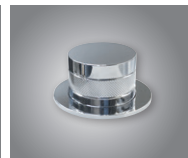

Gömülebilir kumanda  
Ürün No. 0872  
krom 3.920.00 TL  
Ürün No. 0871  
paslanmaz çelik  
4.230.00 TL



Gider kapağı  
paslanmaz çelik  
Ürün No. 0901  
parlak 1.690.00 TL  
Ürün No. 0902  
satine 1.850.00 TL



Sıvı sabunluk  
Ürün No. 0903  
krom 11.460.00 TL  
Ürün No. 0904  
paslanmaz çelik  
12.230.00 TL

## VEGA 100 60 cm enindeki kabinler için - üstten yerleştirmeli eviye



### Ölçüler / Yerleştirme çizimleri

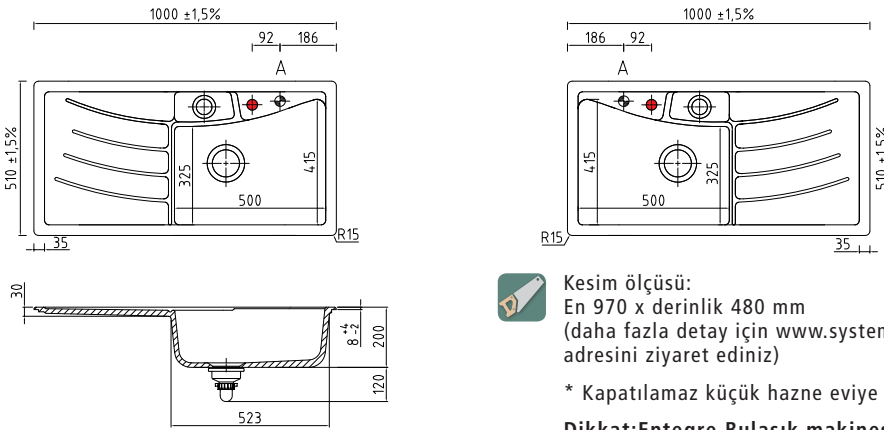

**Kesim ölçüsü:**  
En 970 x derinlik 480 mm  
(daha fazla detay için [www.systemceram.de](http://www.systemceram.de)  
adresini ziyaret ediniz)

\* Kapatılmaz küçük hazne eviye gideri

**Dikkat:Entegre Bulaşık makinesi  
durumunda min. tezgah kalınlığı 30 mm.**

● Armatür deliği ve ● önceden kırılmaya hazır kırılma noktası vardır. (A noktası) Ø ~ 35 mm.

### Özel Renkler



Fango 23

KERADOMO VEGA 100	Ürün No.	Standart Renkler	Özel Renkler
	Sağ hazne		
Otomatik gider ile, paslanmaz çelik yuvarlak kumanda, Ø 45 mm ve siğ süzgeç Makrolon	5032 02 23 FANGO		57.500.00 TL

Dikkat, lütfen renk numarasını belirtiniz.

### Özel aksesuarlar

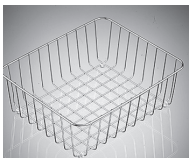

**Sepet**  
paslanmaz çelik  
Sağ hazne  
Ürün No. 0816  
6.770.00 TL



**Kesme tahtası**  
cam  
Ürün No. 0738  
1.550.00 TL



**Kesme tahtası**  
ahşap  
Ürün No. 0743  
5.300.00 TL

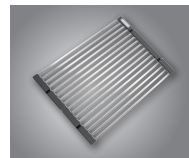

**Katlanabilir ızgara/  
Rollmat**  
paslanmaz çelik  
310 x 450 mm  
Ürün No. 0841  
6.070.00 TL

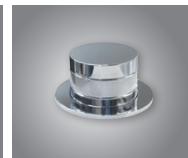

**Gömülebilir kumanda**  
Ürün No. 0872  
krom 3.920.00 TL  
Ürün No. 0871  
paslanmaz çelik  
4.230.00 TL



**Gider kapağı**  
paslanmaz çelik  
Ürün No. 0901  
parlak 1.690.00 TL  
Ürün No. 0902  
satine 1.850.00 TL



**Sıvı sabunluk**  
Ürün No. 0903  
krom 11.460.00 TL  
Ürün No. 0904  
paslanmaz çelik  
12.230.00 TL

**MERA 80** 80 cm enindeki kabinler için - üstten yerleştirmeli eviye

## Standart Renkler

Grönland 12  
glossy

Polar 13



Siena 65

Nero 68  
glossy

Alu 76

## Özel Renkler

Magnolie 10  
glossy

Jasmin 19



Fango 23



Titan 78



Lava 80



Schiefer 85



Nigra 87

Dikkat, lütfen renk numarasını belirtiniz.

## Ölçüler / Yerleştirme çizimleri

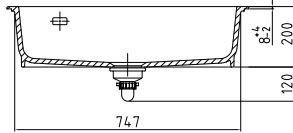
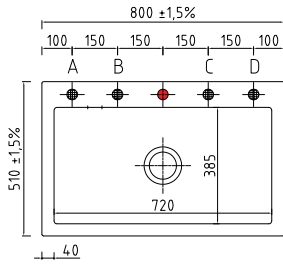
Kesim ölçüsü:  
En 770 x derinlik 480 mm  
(daha fazla detay için [www.systemceram.de](http://www.systemceram.de)  
adresini ziyaret ediniz)

● Armatür deliği vardır. Önceden kırılmaya hazır kırılma noktaları yoktur. Kişisel isteğe göre delik açılır. (● A ve B noktası, lütfen çizime bakınız). Ø ~ 35 mm.

KERADOMO MERA 80	Ürün No.	Standart Renkler	Özel Renkler
Manuel gider ile	5070 01	51.900.00 TL	55.200.00 TL
Otomatik gider ile, paslanmaz çelik yuvarlak kumanda, Ø 45 mm	5070 02	55.200.00 TL	58.850.00 TL

## Özel aksesuarlar

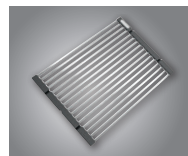
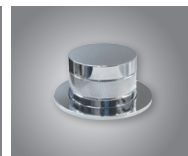
Derin süzgeç  
paslanmaz çelik  
Ürün No. 0831  
12.690.00 TLKesme tahtası  
cam  
Ürün No. 0735  
7.150.00 TLKesme tahtası  
ahşap  
Ürün No. 0739  
5.300.00 TLKatlanabilir ızgara/  
Rollmat  
paslanmaz çelik  
310 x 450 mm  
Ürün No. 0841  
6.070.00 TLGömülebilir kumanda  
Ürün No. 0872  
krom 3.920.00 TL  
Ürün No. 0871  
paslanmaz çelik  
4.230.00 TLGider kapağı  
paslanmaz çelik  
Ürün No. 0901  
parlak 1.690.00 TL  
Ürün No. 0902  
satine 1.850.00 TLSıvı sabunluk  
Ürün No. 0903  
krom 11.460.00 TL  
Ürün No. 0904  
paslanmaz çelik  
12.230.00 TL

## MERA DOUBLE 80 cm enindeki kabinler için - üstten yerleştirmeli eviye



### Standart Renkler



Grönland 12  
glossy



Polar 13



Siena 65



Nero 68  
glossy



Alu 76

### Özel Renkler



Magnolie 10  
glossy



Jasmin 19



Fango 23



Titan 78



Lava 80



Schiefer 85



Nigra 87

Dikkat, lütfen renk numarasını belirtiniz.

### Ölçüler / Yerleştirme çizimleri

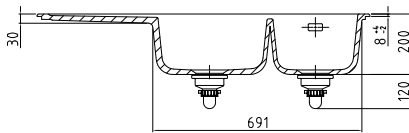
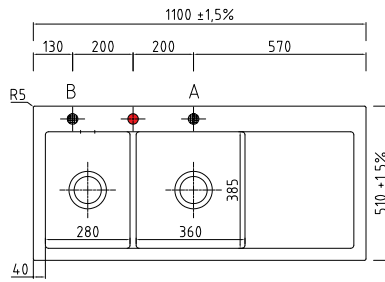
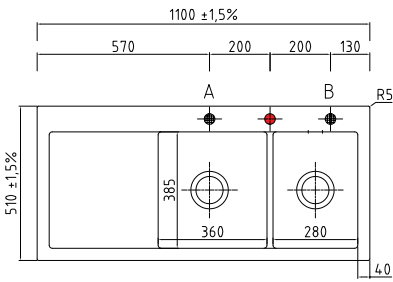

Kesim ölçüsü:  
En 1.070 x derinlik 480 mm  
(daha fazla detay için [www.systemceram.de](http://www.systemceram.de)  
adresini ziyaret ediniz)

**Dikkat:Entegre Bulaşık makinesi  
durumunda min. tezgah kalınlığı 20 mm.**

● Armatür deliği vardır. Önceden kırılmaya hazır kırılma noktaları yoktur. Kişisel isteğe göre delik açılır. (● A ve B noktası, lütfen çizime bakınız). Ø ~ 35 mm.

KERADOMO MERA DOUBLE	Ürün No.	Standart Renkler	Özel Renkler
	Sağ hazne/Sol hazne		
Manuel gider ile	5078 01 / 5079 01	72.950.00 TL	79.650.00 TL
Otomatik gider ile, paslanmaz çelik yuvarlak kumanda, Ø 45 mm	5078 02 / 5079 02	79.650.00 TL	83.450.00 TL

### Özel aksesuarlar



Derin süzgeç  
paslanmaz çelik  
Ürün No. 0831  
12.690.00 TL

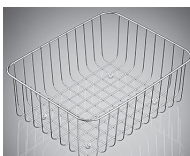

Sepet  
paslanmaz çelik  
Ürün No. 0760  
7.300.00 TL



Kesme tahtası  
cam  
Ürün No. 0735  
7.150.00 TL

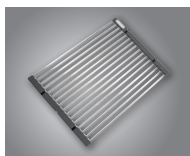

Katlanabilir ızgara/  
Rollmat  
paslanmaz çelik  
310 x 450 mm  
Ürün No. 0841  
6.070.00 TL

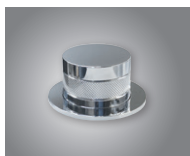

Gömülebilir kumanda  
Ürün No. 0872  
Ürün No. 0871  
paslanmaz çelik  
4.230.00 TL



Gider kapağı  
paslanmaz çelik  
Ürün No. 0901  
parlak 1.690.00 TL  
Ürün No. 0902  
satine 1.850.00 TL



Sıvı sabunluk  
Ürün No. 0903  
krom 11.460.00 TL  
Ürün No. 0904  
paslanmaz çelik  
12.230.00 TL



**CENTRA 90** 90 cm enindeki kabinler için - tezgahtan taşmalı eviye

## Önerilen batarya

## RETRO



Renk	krom
Ürün No.	10055
Fiyat	10.550.00 TL

## Ölçüler/Yerleştirme çizimleri

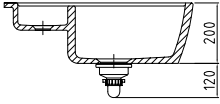
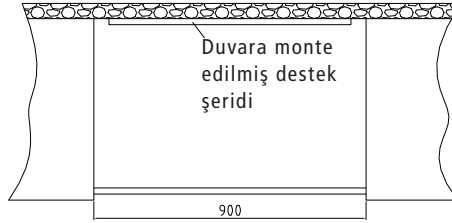
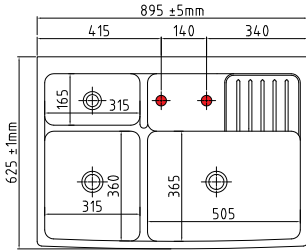

**Dikkat!** sadece iki dolap arasında kurulum için uygundur. Arka kısım kapalı değildir.

Eviye modellerinin ölçüleri 600 mm (standart ölçü) ile 750 mm (özel üretim) arasında isteğe göre değişiklik göstermektedir. Örneğin, alt dolap kapağı ile (resimde görüldüğü gibi) eviyenin sırtının dayanacağı duvar, pano arasındaki ölçü cihazın sipariş ölçüsüdür.

\* Küçük haznede sifon kontrolsüz gider

● Armatür ve ● otomatik sifon için delik vardır. Ø ~ 35 mm

KERADOMO CENTRA 90	Ürün No.	Standart renkler	Özel renkler
Eviye derinliği 600 mm - Otomatik gider ile, paslanmaz çelik yuvarlak kumanda, Ø 45 mm	5095 02	98.900.00 TL	99.900.00 TL
Eviye derinliği 601 mm - 750 mm - Otomatik gider ile, paslanmaz çelik yuvarlak kumanda, Ø 45 mm	5096 02	99.900.00 TL	103.200.00 TL

## Standart renkler



Grönland 12  
glossy



Polar 13



Siena 65



Nero 68  
glossy



Alu 76

## Özel renkler



Magnolie 10  
glossy



Jasmin 19



Fango 23



Titan 78



Lava 80



Schiefer 85



Nigra 87

Dikkat, lütfen renk numarasını belirtiniz.

## Özel aksesuarlar



**Sepet**  
paslanmaz çelik  
Ürün No. 0810  
7.300.00 TL

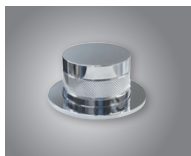

**Gömülebilir kumanda**  
Ürün No. 0872  
krom 3.920.00 TL  
Ürün No. 0871  
paslanmaz çelik  
4.230.00 TL



**Gider kapağı**  
paslanmaz çelik  
Ürün No. 0901  
parlak 1.690.00 TL  
Ürün No. 0902  
satine 1.850.00 TL

### ISI ŞOKLARINA DİRENÇ

Fırından çıkartılan ince keramik şoklara dayanıklıdır. Isıdaki değişimlere özellikle yüksek bir direnç göstermektedir.



### ASİDE KARŞI DİRENÇ

Dayanıklı bir şekilde, seramik tüm evsel temizlik kimyasallarına ve hatta „meyve/sebze suları“ gibi renk yoğunluğu bulunan sıvılara karşı koyabilmektedir.



### DARBEYE VE ÇARPMAYA DİRENÇLİ

İnce keramik serttir. Ayrıca, darbe ve çarpmalara dirençlidir.



### HİJYENİK

Pürüzsüz seramik yüzeyler üzerinde hiçbirşey uzun süre kalmaz. Bunlar, kolayca temizlenir, tatsız ve kokusuz olup, son derece hijyeniktir.



### KESMEYE KARŞI DİRENÇLİ

KeraDomo mutfak seramiği kesme işleminin uygulanması için son derece mükemmel bir alandır.





## CERAMIC SINKS Tezgaha sifir seramik eviyeler

### Dikkat:

Tezgah kalınlığı minimum 33 mm. olmalıdır.

İnce tezgahlar için uygulama, alt kısma yapılacak destek ile veya ürün fiyat çizelgesinde bulunan 9055 kodlu işlem ile (bu işlem de eviyenin kenar kalınlığı 10 mm düşünülmektedir.) mümkündür.

Eviye tezgahın üst kısmından 1-2 mm aşağıdan olacak şekilde planlanmalı ve tezgahın üst kenar kısmı 45 derece olmalı. Kesimlerde, üst kenara 2 mm x 45 derecelik bir boşluk uygulanmalıdır.

Kat derinliği: 25 mm

Kat eni: 8 mm



### Kurulum Önerisi



Eviye etrafındaki destek şeritleri sabit olarak bağlandığı zaman, uygun sabitlik ve ürünün düzgün olarak ayarlanması sağlanmaktadır.



Yapıştırma: Fabrika tarafından verilen kendinden-yapışkanlı esnek kurulum bantının kullanımı. Yerleştirin ve bastırın. Böylelikle, yardımcı bir silikon bariyeri oluşmaktadır.



Yerleştirme: Eviye tabanındaki gider deliğini tek elle tutarak yerleştirmek en doğru yöntemdir.



Ayarlama: Eviye etrafında eşit yükseklikler ayarlamak için, verilen milimetre kalınlığındaki ahşap parçaları alt taraftan kurulum bantı ile eviye köşesi arasına yerleştiriniz.



Ayarlama: Yatay olarak dikkatlice baskı uygulayınız.



Silikon uygulaması: Taş işleme firmaları tarafından önerilen sadece suya-dayanımlı, nötr kür silikon kullanılmalıdır.



Silikon uygulaması: Silikon sonunda yumuşatıldığı zaman, sıkı ve taş ile seramik arasında neredeyse gözükmeyen boşluk kalmaktadır.

## SERAMİK, DOĞAL TAŞ İLE BİRLEŞTİ.

Tezgaha sifir kurulumun **PRATİK AVANTAJLARININ** olduğu ortadadır. 15 farklı renkte KeraDomo seramik eviye olması ve **KURULUMUN DAHA AZ ÇABA İLE YAPILMASI İLE BU TIP EVİYE SEÇİMİNİ KOLAYLAŞTIRMAKTADIR.**

**MERA 57 F** 60 cm enindeki kabinler için - tezgaha sıfır eviye

## Standart renkler

Grönland 12  
glossy

Polar 13



Siena 65

Nero 68  
glossy

Alu 76

## Ölçüler/Yerleştirme çizimleri

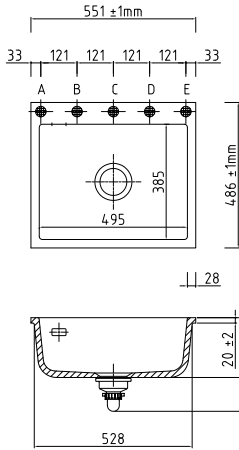

Kesim ölçüsü:  
En 555 x derinlik 490 mm  
(daha fazla detay için [www.systemceram.de](http://www.systemceram.de)  
adresini ziyaret ediniz)

**Dikkat! Sipariştten önce sayfa 44'deki  
kurulum şartlarını kontrol ediniz**

Armatür deliği ve önceden kırılmaya hazır kırılma noktaları yoktur. Kişisel isteğe göre delik açılır.  
(A, B, C, D ve E noktası, lütfen çizime bakınız). Ø ~ 35 mm.

KERADOMO MERA 57 F	Ürün No.	Standart renkler	Özel renkler
Manuel gider ile	5557 01	48.250.00 TL	52.950.00 TL
Otomatik gider ile, paslanmaz çelik yuvarlak kumanda, Ø 45 mm	5557 02	52.950.00 TL	58.500.00 TL
Flanj radius 4xR10	9050	6.390.00 TL	
Kenar kalınlığı 10 mm'ye indirilebilir	9055	4.250.00 TL	

## Özel renkler

Magnolie 10  
glossy

Jasmin 19



Fango 23



Titan 78



Lava 80



Schiefer 85



Nigra 87

Dikkat, lütfen renk numarasını belirtiniz

## Özel aksesuarlar



**Derin süzgeç**  
paslanmaz çelik  
Ürün No. 0831  
12.690.00 TL



**Sepet**  
paslanmaz çelik  
Ürün No. 0722  
7.385.00 TL



**Kesme tahtası**  
cam  
Ürün No. 0736  
6.140.00 TL

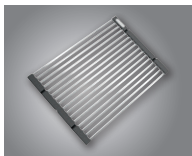

**Katlanabilir ızgara/  
Rollmat**  
paslanmaz çelik  
310 x 450 mm  
Ürün No. 0841  
6.070.00 TL

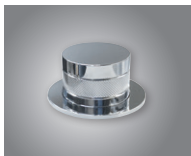

**Gömülebilir kumanda**  
Ürün No. 0872  
krom 3.920.00 TL  
Ürün No. 0871  
paslanmaz çelik  
4.230.00 TL



**Gider kapağı**  
paslanmaz çelik  
Ürün No. 0901  
parlak 1.690.00 TL  
Ürün No. 0902  
satine 1.850.00 TL



**Sıvı sabunluk**  
Ürün No. 0903  
krom 11.460.00 TL  
Ürün No. 0904  
paslanmaz çelik  
12.230.00 TL

## NERA 100 SL / F 60 cm enindeki kabinler için - tezgaha sıfır eviye



### Standart renkler



Grönland 12  
glossy



Polar 13



Siena 65



Nero 68  
glossy



Alu 76

### Ölçüler/Yerleştirme çizimleri

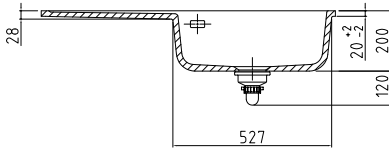
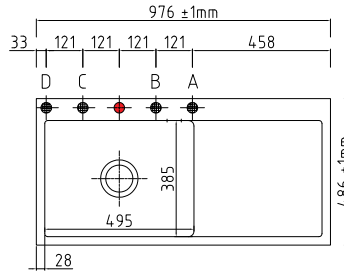
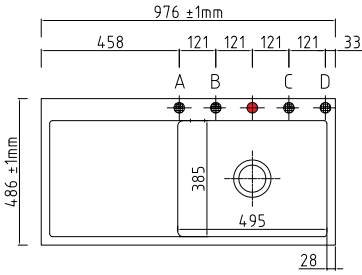

**Kesim ölçüsü:**  
En 980 x derinlik 490 mm  
(daha fazla detay için [www.systemceram.de](http://www.systemceram.de) adresini ziyaret ediniz)

**Dikkat! Entegre Bulaşık makinesi durumunda min. tezgah kalınlığı 30 mm. Siparişten önce sayfa 44'deki kurulum şartlarını kontrol ediniz.**

● Armatür deliği vardır. Önceden kırılmaya hazır kırılma noktaları yoktur. Kişisel isteğe göre delik açılır. (● A, B, C ve D noktası, lütfen çizime bakınız). Ø ~ 35 mm.

### Özel renkler



Magnolie 10  
glossy



Jasmin 19



Fango 23



Titan 78



Lava 80



Schiefer 85



Nigra 87

Dikkat, lütfen renk numarasını belirtiniz.

KERADOMO NERA 100 SL / F	Ürün No.	Standart renkler	Özel renkler
	Sağ hazne / Sol hazne		
Manuel gider ile	5564 01 / 5565 01	62.300.00 TL	67.300.00 TL
Otomatik gider ile, paslanmaz çelik yuvarlak kumanda, Ø 45 mm	5564 02 / 5565 02	67.300.00 TL	72.250.00 TL
Flanj radius 4xR10	9050	6.390.00 TL	

### Özel aksesuarlar



**Derin süzgeç**  
paslanmaz çelik  
Ürün No. 0831  
12.690.00 TL

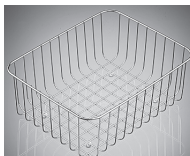

**Sepet**  
paslanmaz çelik  
Ürün No. 0722  
7.385.00 TL



**Kesme tahtası**  
cam  
Ürün No. 0736  
6.140.00 TL

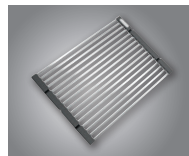

**Katlanabilir ızgara/ Rollmat**  
paslanmaz çelik  
310 x 450 mm  
Ürün No. 0841  
6.070.00 TL

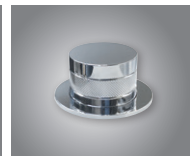

**Gömülebilir kumanda**  
Ürün No. 0872  
krom 3.920.00 TL  
Ürün No. 0871  
paslanmaz çelik  
4.230.00 TL



**Gider kapağı**  
paslanmaz çelik  
Ürün No. 0901  
parlak 1.690.00 TL  
Ürün No. 0902  
satine 1.850.00 TL



**Sıvı sabunluk**  
Ürün No. 0903  
krom 11.460.00 TL  
Ürün No. 0904  
paslanmaz çelik  
12.230.00 TL

## MERA 80 F 80 cm enindeki kabinler için - tezgaha sıfır eviye



### Standart renkler



Grönland 12  
glossy



Polar 13



Siena 65



Nero 68  
glossy



Alu 76

### Özel renkler



Magnolie 10  
glossy



Jasmin 19



Fango 23



Titan 78



Lava 80



Schiefer 85



Nigra 87

Dikkat, lütfen renk numarasını belirtiniz.

### Ölçüler/Yerleştirme çizimleri

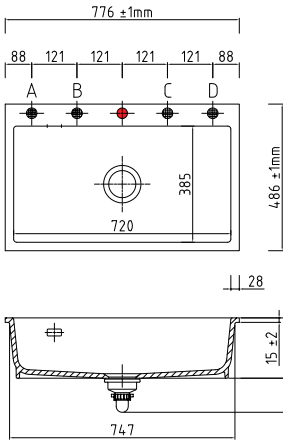

Kesim ölçüsü:  
En 780 x derinlik 490 mm  
(daha fazla detay için [www.systemceram.de](http://www.systemceram.de)  
adresini ziyaret ediniz)

**Dikkat! Siparişten önce sayfa 44'deki  
kurulum şartlarını kontrol ediniz.**

● Armatür deliği vardır. Önceden kırılmaya hazır kırılma noktaları yoktur. Kişisel isteğe göre delik açılır (A, B, C ve D noktası, lütfen çizime bakınız). Ø ~ 35 mm.

KERADOMO MERA 80 F	Ürün No.	Standart renkler	Özel renkler
Manuel gider ile	5570 01	55.770.00 TL	62.250.00 TL
Otomatik gider ile, paslanmaz çelik yuvarlak kumanda, Ø 45 mm	5570 02	62.250.00 TL	65.700.00 TL
Flanj radius 4xR10	9050	6.390.00 TL	
Kenar kalınlığı 10 mm'ye indirilebilir	9055	4.250.00 TL	

### Özel aksesuarlar



**Derin süzgeç**  
paslanmaz çelik  
Ürün No. 0831  
12.690.00 TL



**Kesme tahtası**  
cam  
Ürün No. 0736  
6.140.00 TL



**Kesme tahtası**  
ahşap  
Ürün No. 0739  
5.300.00 TL

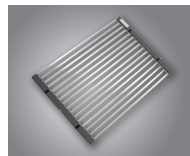

**Katlanabilir ızgara/  
Rollmat**  
paslanmaz çelik  
310 x 450 mm  
Ürün No. 0841  
6.070.00 TL

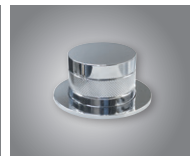

**Gömülebilir kumanda**  
Ürün No. 0872  
krom 3.920.00 TL  
Ürün No. 0871  
paslanmaz çelik  
4.230.00 TL



**Gider kapağı**  
paslanmaz çelik  
Ürün No. 0901  
parlak 1.690.00 TL  
Ürün No. 0902  
satine 1.850.00 TL



**Sıvı sabunluk**  
Ürün No. 0903  
krom 11.460.00 TL  
Ürün No. 0904  
paslanmaz çelik  
12.230.00 TL

## MERA 32 U 45 cm enindeki kabinler için - alttan yerleştirme eviye



### Standart renkler



Grönland 12  
glossy



Polar 13



Siena 65



Nero 68  
glossy



Alu 76

### Özel renkler



Magnolie 10  
glossy



Jasmin 19



Fango 23



Titan 78



Lava 80



Schiefer 85



Nigra 87

Dikkat, lütfen renk numarasını belirtiniz.

### Ölçüler/Yerleştirme çizimleri

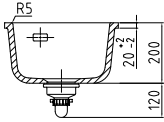
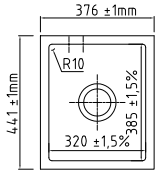

Kesim ölçüsü:  
En 310 x derinlik 375 mm, R 6mm

Size önerimiz kesim yerini toleranslardan dolayı (+/- %1,5) eviyeler tarafınıza ulaştığı zaman hazırlayınız.

\* Armatür deliği yoktur. Delikler tezgah üzerinde planlanmalıdır.

KERADOMO MERA 32 U	Ürün No.	Standart renkler	Özel renkler
Manuel gider ile	5361 01	39.900.00 TL	43.850.00 TL
Otomatik gider ile, paslanmaz çelik yuvarlak kumanda, Ø 45 mm	5361 02	43.850.00 TL	48.200.00 TL

### Özel aksesuarlar



**Derin Süzgeç**  
Paslanmaz çelik  
Ürün No. 0831  
12.690.00 TL

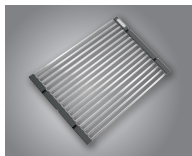

**Katlanabilir ızgara/  
Rollmat**  
Paslanmaz çelik  
310 x 450 mm  
Ürün No. 0841  
6.070.00 TL

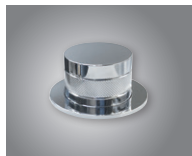

**Gömülebilir kumanda**  
Ürün No. 0872  
krom 3.920.00 TL  
Ürün No. 0871  
paslanmaz çelik  
4.230.00 TL



**Gider kapağı**  
paslanmaz çelik  
Ürün No. 0901  
parlak 1.690.00 TL  
Ürün No. 0902  
satine 1.850.00 TL



**Sıvı sabunluk**  
Ürün No. 0903  
krom 11.460.00 TL  
Ürün No. 0904  
paslanmaz çelik  
12.230.00 TL



## MERA 50 U 60 cm enindeki kabinler için - alttan yerleştirme eviye



### Standart renkler



Grönland 12  
glossy



Polar 13



Siena 65



Nero 68  
glossy



Alu 76

### Özel renkler



Magnolie 10  
glossy



Jasmin 19



Fango 23



Titan 78



Lava 80



Schiefer 85



Nigra 87

Dikkat, lütfen renk numarasını belirtiniz.

### Ölçüler/Yerleştirme çizimleri

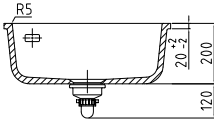
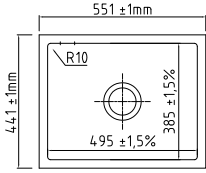

Kesim ölçüsü:  
En 483 x derinlik 375 mm, R 6mm

Size önerimiz kesim yerini toleranslardan dolayı ( $\pm 1,5\%$ ) eviyeler tarafınıza ulaştığı zaman hazırlayınız.

\* Armatür deliği yoktur. Delikler tezgah üzerinde planlanmalıdır.

KERADOMO MERA 50 U	Ürün No.	Standart renkler	Özel renkler
Manuel gider ile	5357 01	47.800.00 TL	52.500.00 TL
Otomatik gider ile, paslanmaz çelik yuvarlak kumanda Ø 45 mm	5357 02	52.500.00 TL	57.750.00 TL



**Derin Süzgeç**  
Paslanmaz çelik  
Ürün No. 0831  
12.690.00 TL



**Sepet**  
Paslanmaz çelik  
Ürün No. 0722  
7.385.00 TL

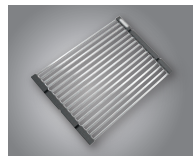

**Katlanabilir ızgara/  
Rollmat**  
Paslanmaz çelik  
310 x 450 mm  
Ürün No. 0841  
6.070.00 TL

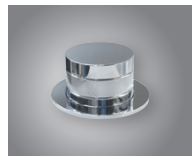

**Gömülebilir kumanda**  
Ürün No. 0872  
krom 3.920.00 TL  
Ürün No. 0871  
paslanmaz çelik  
4.230.00 TL



**Gider kapağı**  
paslanmaz çelik  
Ürün No. 0901  
parlak 1.690.00 TL  
Ürün No. 0902  
satine 1.850.00 TL



**Sıvı sabunluk**  
Ürün No. 0903  
krom 11.460.00 TL  
Ürün No. 0904  
paslanmaz çelik  
12.230.00 TL

## MERA 60 U 60 cm enindeki kabinler için - alttan yerleştirme eviye



### Standart renkler



Grönland 12  
glossy



Polar 13



Siena 65



Nero 68  
glossy



76

### Özel renkler



Magnolie 10  
glossy



Jasmin 19



Fango 23



Titan 78



Lava 80



Schiefer 85



Nigra 87

Dikkat, lütfen renk numarasını belirtiniz.

### Ölçüler/Yerleştirme çizimleri

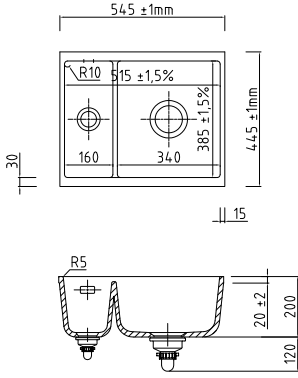

Kesim ölçüsü:  
En 483 x derinlik 375 mm, R 6mm

Size önerimiz kesim yerini toleranslardan dolayı ( $\pm 1,5\%$ ) eviyeler tarafınıza ulaştığı zaman hazırlayınız.

\* Armatür deliği yoktur. Delikler tezgah üzerinde planlanmalıdır.

KERADOMO MERA 60 U	Ürün No.	Standart renkler	Özel renkler
Manuel gider ile	5398 01	51.950.00 TL	56.950.00 TL
Otomatik gider ile, paslanmaz çelik yuvarlak kumanda Ø 45 mm	5398 02	56.950.00 TL	62.600.00 TL

### Özel aksesuarlar



**Derin Süzgeç**  
Paslanmaz çelik  
Ürün No. 0831  
12.690.00 TL

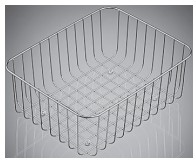

**Sepet**  
Paslanmaz çelik  
Ürün No. 0760  
7.300.00 TL

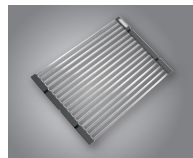

**Katlanabilir ızgara/  
Rollmat**  
Paslanmaz çelik  
310 x 450 mm  
Ürün No. 0841  
6.070.00 TL

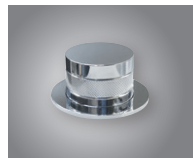

**Gömülebilir kumanda**  
Ürün No. 0872  
krom 3.920.00 TL  
Ürün No. 0871  
paslanmaz çelik  
4.230.00 TL



**Gider kapağı**  
paslanmaz çelik  
Ürün No. 0901  
parlak 1.690.00 TL  
Ürün No. 0902  
satine 1.850.00 TL



**Sıvı sabunluk**  
Ürün No. 0903  
krom 11.460.00 TL  
Ürün No. 0904  
paslanmaz çelik  
12.230.00 TL

## MERA 80 U 80 cm enindeki kabinler için - alttan yerleştirme eviye



### Standart renkler



Grönland 12  
glossy



Polar 13



Siena 65



Nero 68  
glossy



Alu 76

### Özel renkler



Magnolie 10  
glossy



Jasmin 19



Fango 23



Titan 78



Lava 80



Schiefer 85



87

Dikkat, lütfen renk numarasını belirtiniz.

### Ölçüler/Yerleştirme çizimleri

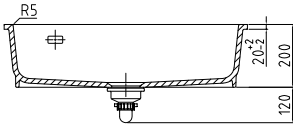
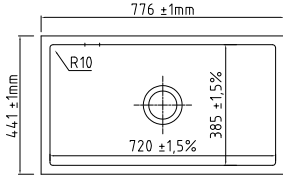

Kesim ölçüsü:  
En 705 x derinlik 375 mm, R 6mm

Size önerimiz kesim yerini toleranslardan dolayı ( $\pm 1,5\%$ ) eviyeler tarafınıza ulaştığı zaman hazırlayınız.

\* Armatür deliği yoktur. Delikler tezgah üzerinde planlanmalıdır.

KERADOMO MERA 80 U	Ürün No.	Standart renkler	Özel renkler
Manuel gider ile	5370 01	53.500.00 TL	58.800.00 TL
Otomatik gider ile, paslanmaz çelik yuvarlak kumanda Ø 45 mm	5370 02	58.800.00 TL	64.600.00 TL

### Özel aksesuarlar



**Derin Süzgeç**  
Paslanmaz çelik  
Ürün No. 0831  
12.690.00 TL

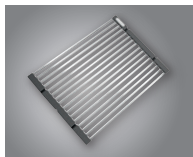

**Katlanabilir ızgara/  
Rollmat**  
Paslanmaz çelik  
310 x 450 mm  
Ürün No. 0841  
6.070.00 TL

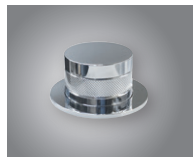

**Gömülebilir kumanda**  
Ürün No. 0872  
krom 3.920.00 TL  
Ürün No. 0871  
paslanmaz çelik  
4.230.00 TL



**Gider kapağı**  
paslanmaz çelik  
Ürün No. 0901  
parlak 1.690.00 TL  
Ürün No. 0902  
satine 1.850.00 TL



**Sıvı sabunluk**  
Ürün No. 0903  
krom 11.460.00 TL  
Ürün No. 0904  
paslanmaz çelik  
12.230.00 TL

Her bir eviye, detaylarına kadar incelenmiş eşsiz bir porselen seramik üründür. Kısmen manuel, kısmen mekanik ve **CAD** kontrollü (bilgisayar yardımlı) üretim şartları ideal üretim ortamını yaratmaktadır.

Özel bir malzeme ve yüzey kaliteleri mutfak ortamında test edildiği zaman, **KERADOMO MUTFAK SERAMİKLERİ** en iyi sonucu vermektedir. Yüksek dirençliliği, **LABORATUVAR EVİYELERİ VE TEZGAHLARI ÜRETİMİNİN BİLGİ-BİRİKİMİ** sonucudur. Lütfen aşağıdaki tavsiyeye uyunuz. Bunu yaparken, eviyelerin fiziksel durumlarına ve düzgün işleyişine önemli bir etki ettiğini göreceksiniz. Systemceram, sadece ürün kusurundan dolayı meydana gelmiş ve kanıtlanmış hasarlardan sorumludur.



Temizlik Malzemesi  
**BIOTOPP** 350 g (sünger dahildir)

## KERADOMO MUTFAK EVİYELERİ

- Temizlik için sadece ılık su ve biraz bulaşık deterjanına ihtiyaç vardır.
- Kabuk tutmuş kirler sadece kısmen aşındırıcı madde içeren deterjanlar (Örn. Systemceram tarafında sunulan BioTopp veya piyasada satılan Cerafix) ve çizilme yapmayacak bulaşık sünger ile çıkartılabilir.
- Seramik yüzey metalden daha sert olduğu için, metal (Örn. tavaların alt kısımları) aşındırma yapabilir. Aşınma izlerinin olduğu durumda, piyasada seramik cam ocaklar için uygun temizlik malzemesi Cerafix kullanılabilir.
- Seramik yüzeye sivri uçlu sert objeler temas ettirilmemeli ve seramik bıçaklar kullanılmamalıdır. Bunların olası kullanımı durumunda çizilmeler meydana gelebilmektedir.

### Cleanplus Yüzeyle KeraDomo-Mutfak Eviyeleri

- Temizlik için sadece ılık su ve biraz bulaşık deterjanına ihtiyaç vardır.
- Sadece çizilme yapmayan yumuşak süngerler veya havlular kullanılmalıdır.
- Temizleme malzemesi kullanılacağı zaman, lütfen sadece hafif sirke bazlı veya çok-amaçlı temizlik malzemeleri

- kullanılmalıdır (Örn. Frosch Essig Reiniger (sirke-bazlı temizleyici), Frosch Neutral Reiniger (nötr temizleyici), viss Glas & Flachen (cam ve yüzeyler için), Bref Power Reiniger (güçlü temizleyici), Bref Hygiene Reiniger (hijyenik temizleyici), Sidolin streifenfrei Cristal, Cillit Bang Kraftreiniger (güçlü temizleyici), biff Fresh-Shower).
- Örn. nötr veya düşük pH değerine sahip Kireç temizleyici veya nötr temizleyiciler gibi hafif temizlik malzemeleri önerilmektedir. İstek doğrultusunda, kaplı yüzeyler için yenileyici bakım ürünü alabilirsiniz.
- Seramik yüzey metalden daha sert olduğu için, metal (Örn. tavaların alt kısımları) aşındırma yapabilir. Aşınma izlerinin olduğu durumda, piyasada seramik cam ocaklar için uygun temizlik malzemesi Cerafix kullanılabilir.
- Şunu bilmelisiniz ki aşındırıcı temizlik malzemeleri (Örn. aşındırıcı süt, aşındırıcı toz, drenaj temizleyici, seramik cam, ocak ve paslanmaz çelik temizleyicileri) CleanPlus özelliklerine hasar vermekte ve cilayı çizmektedir. Bu sebeple, bunları kullanmayınız.
- Seramik yüzeye sivri uçlu sert objeler temas ettirilmemeli ve seramik bıçaklar kullanılmamalıdır. Bunların olası kullanımı durumunda çizilmeler meydana gelebilmektedir.

### **Bu katalogta yer alan ürünlere ait fiyatlar tavsiye edilen perakende fiyatlarıdır.**

BOĞAZIÇI İTHALAT DIŞ TİCARET PAZARLAMA LTD. ŞTİ fiyatları ve faaliyet içinde bulunan ürün listesini değiştirme hakkına sahiptir. BOĞAZIÇI İTHALAT DIŞ TİCARET PAZARLAMA LTD. ŞTİ. baskıdan kaynaklı hatalardan sorumlu değildir.

Broşürde yer alan ürünlere ait renkler, baskı sebebi ile farklılık gösterebilir.

# KERADOMO ARMATÜRLER

LIVE



Tek-kumanda kollu çıkartılabilir başlıklı armatür LIVE

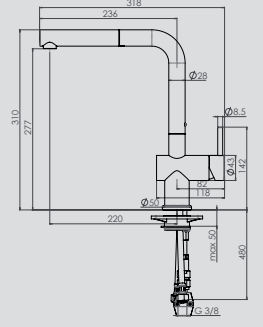

Ürün tanımı / Doku-renk

Pencere önü kurulum için tek-kumandalı çıkarılabilir başlıklı armatür LIVE, krom\*

Ürün No.

10079

TL

23.900.00

Tek-kumandalı armatür SNELLA

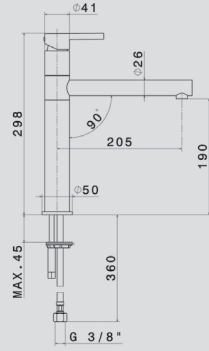

Ürün tanımı / Doku-renk

Tek-kumandalı armatür SNELLA, krom/siyah (Nero 68 ve Nigra 87 için)

Ürün No.

18576

TL

30.700.00



## KERADOMO ARMATÜRLER

### Tek-kumandalı çıkartılabilir başlıklı BINGO STAR

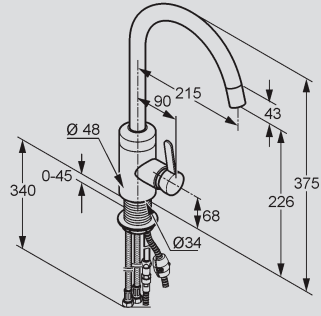

Ürün tanımı / Doku-renk	Ürün No.	TL
Tek-kumandalı armatür BINGO STAR çıkartılabilir başlıklı, krom	10082	22.200.00
Tek-kumandalı armatür BINGO STAR çıkartılabilir başlıklı, Lava	18082	23.950.00

### Tek-kumandalı armatür RETRO

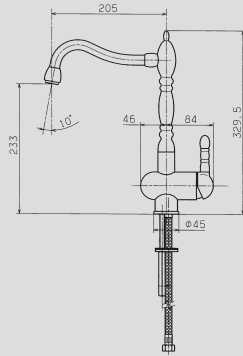



Ürün tanımı / Doku-renk	Ürün No.	TL
Tek-kumandalı armatür RETRO, krom	10055	33.770.00

## AKSESUARLAR



### Gömülebilir kumandalı gider düğmesi

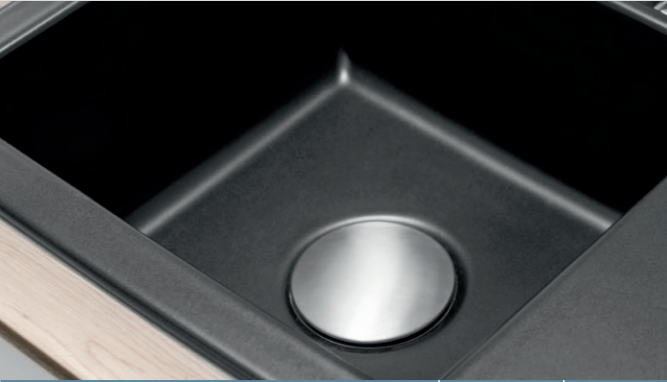

Ürün tanımı / Doku-renk	Ürün No.	TL
 Kumandalı gider düğmesi, krom	0872	3.920.00
 Kumandalı gider düğmesi, paslanmaz çelik	0871	4.230.00

### Gider kapağı



Ürün tanımı / Doku-renk	Ürün No.	TL
 Eviye gider kapağı, parlak çelik	0901	1.690.00
 Eviye gider kapağı, Satine paslanmaz çelik	0902	1.850.00

### Paslanmaz çelik katlanabilir ızgara



Ürün tanımı / Doku-renk	Ürün No.	TL
Paslanmaz çelik katlanabilir ızgara 310 x 450 mm	0841	6.070.00

### Sıvı sabunluk

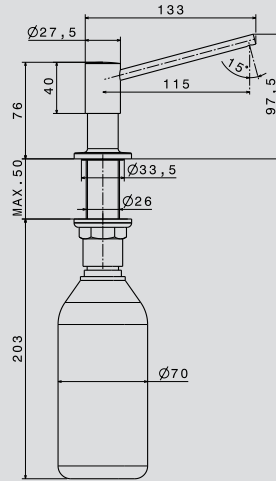

Plastik alt kısım yukarı bölümden doldurulmaktadır (500 ml)





Ürün tanımı / Doku-renk	Ürün No.	TL
Sıvı sabunluk, krom	0903	11.460.00
Sıvı sabunluk, Paslanmaz çelik	0904	12.230.00

# AKSESUARLAR VE YEDEK PARÇALAR

YEDEK PARÇALAR	Ürün No.	TL	
<b>(Model no / tanım ve teslimat yılı belirtmek zorunludur.)</b>			
	<b>Alba gider (manuel 115 mm)</b> birçok parçadan oluşmaktadır (00792 & 00777): Bela 57, Bela 78, Bela 100, Cea 57, Genea 87, Kappa 86, Mera Eck, Mera 39, Mera 70, Mera 90, Mera 46, Mera 57, Mera Middle, Quanto 60, Mera 100SL, Siro 100, Mera 80, Quanto 90, Siro 90, Stema 80, Stema 90, (Zeta 32, Zeta 40, Zeta 50)	0873	3.230.00
	<b>Alba gider (otomatik 115 mm)</b> (Beta 100), Cea 100, Centra 90, Delta 86, Delta 90, Delta 100, Genea 100, Genea Double, Mera 60, Mera 100 Mera Double, Sigma 52, (Sigma 92), Sinus 87, Sinus Eck, Sinus Double, (Vega 46, Vega 78), Vega 100, Vega Eck, Vega Eck Plus, (Zeta 52), F and U variants	0770	2.850.00
	<b>Alba gider (otomatik 115 mm)</b> birçok parçadan oluşmaktadır (00792, 00776 & 00778): Bela 57, Bela 78, Bela 100, Cea 57, Genea 87, Kappa 86, Mera Eck, Mera 39, Mera 70, Mera 90, Mera 46, Mera 57, Mera Middle, Quanto 60, Mera 100SL, Siro 100, Mera 80, Quanto 90, Siro 90, Stema 80, Stema 90, (Zeta 32, Zeta 40, Zeta 50)	0874	4.770.00
	<b>TG gider (otomatik 115 mm)</b> (Alpha Ergo, Beta 100), Cea 100, Centra 60, Centra 90, Delta 86, Delta 90, Delta 100, Genea 100, Genea Double, Mera 60, Mera 100, Mera Double, Sigma 52, (Sigma 92), Sinus 87, Sinus Eck, Sinus Double, (Vega 46, Vega 78), Vega 100, Vega Eck, Vega Eck Plus, (Zeta 52), F and U variants	0773	4.770.00
	<b>Alba sifon kapağı 80 mm / manuel giderli drenaj set için</b> Bela 57, Bela 78, Bela 100, Cea 57, Genea 87, Kappa 86, Mera Eck, Mera 39, Mera 70, Mera 90, Mera 46, Mera 57, Mera Middle, Quanto 60, Mera 100SL, Siro 100, Mera 80, Quanto 90, Siro 90, Stema 80, Stema 90, (Zeta 32, Zeta 40, Zeta 50)	0777	1.200.00
	<b>TG sifon kapağı 80 mm / manuel giderli drenaj set için</b> (Beta 100), Cea 100, Centra 90, Delta 86, Delta 90, Delta 100, Genea 100, Genea Double, Mera 60, Mera 100, Mera Double, Sigma 52, (Sigma 92), Sinus 87, Sinus Eck, Sinus Double, (Vega 46, Vega 78), Vega 100, Vega Eck, Vega Eck Plus, (Zeta 52), F and U variants	0774	1.200.00
	<b>Alba sifon kapağı 80 mm / manuel giderli drenaj set için</b> Bela 57, Bela 78, Bela 100, Cea 57, Genea 87, Kappa 86, Mera Eck, Mera 39, Mera 70, Mera 90, Mera 46, Mera 57, Mera Middle, Quanto 60, Mera 100SL, Siro 100, Mera 80, Quanto 90, Siro 90, Stema 80, Stema 90, (Zeta 32, Zeta 40, Zeta 50)	0776	1.430.00
	<b>TG sifon kapağı 80 mm / manuel giderli drenaj set için</b> (Alpha Ergo, Beta 100), Cea 100, Centra 60, Centra 90, Delta 86, Delta 90, Delta 100, Genea 100, Genea Double, Mera 60, Mera 100, Mera Double, Sigma 52, (Sigma 92), Sinus 87, Sinus Eck, Sinus Double, (Vega 46, Vega 78), Vega 100, Vega Eck, Vega Eck Plus, (Zeta 52), F and U variants	0775	1.430.00
	<b>TG sifon kapağı 55 mm / manuel giderli küçük eviyeler için</b> (Beta 100), Mera 60, Mera 100	0772	1.200.00
	<b>Alba otomatik sifon kontrol kablosu</b> Bela 57, Bela 78, Bela 100, Cea 57, Genea 87, Kappa 86, Mera Eck, Mera 39, Mera 70, Mera 90, Mera 46, Mera 57, Mera Middle, Quanto 60, Mera 100SL, Siro 100, Mera 80, Quanto 90, Siro 90, Stema 80, Stema 90, (Zeta 32, Zeta 40, Zeta 50)	0778	1.370.00
	<b>TG otomatik sifon kontrol kablosu</b> (Alpha Ergo, Beta 100), Cea 100, Centra 60, Centra 90, Delta 86, Delta 90, Delta 100, Genea 100, Genea Double, Mera 60, Mera 100, Mera Double, Sigma 52, (Sigma 92), Sinus 87, Sinus Eck, Sinus Double, (Vega 46, Vega 78), Vega 100, Vega Eck, Vega Eck Plus, (Zeta 52), F and U variants	0781	1.920.00
	Paslanmaz çelik parlak otomatik sifon kumanda düğmesi yuvarlak 45 mm	0786	1.920.00
	Paslanmaz çelik saten otomatik sifon kumanda düğmesi yuvarlak 45 mm	0795	1.920.00



## AKSESUARLAR VE YEDEK PARÇALAR

Yedek parçalar	Ürün No.	TL	
<b>(Model no / tanım ve teslimat yılı belirtmek zorunludur.)</b>			
	Paslanmaz çelik parlak kare kumanda düğmesi 45 x 45 mm	0796	1.920.00
	Paslanmaz çelik saten kare kumanda düğmesi 45 x 45 mm	0785	1.920.00
	Yer problemi olması durumunda batarya kurulumu için ara parça	40001	1.150.00

Temizlik / Bakım / Onarım	Ürün No.	TL	
	Temizlik malzemesi BioTopp / 350 g. sünger dahildir (CleanPlus için değildir) Minimum sipariş 6 kutu - her biri 350 g.	0852	1.300.00

# systemceram

KeraDomo-Küchenkeramik

www.systemceram.de



- Büroşürde yer alan fiyatlar tavsiye edilen (KDV dahil) perakende satış fiyatları olup 25 AĞUSTOS 2024 tarihinden itibaren geçerlidir.
- Boğaziçi İthalat Dış Tic. Paz. Ltd. Şti. önceden haber vermeksizin ürün kodu, görünüm, renk, model ve fiyatları değiştirme hakkına sahiptir.
- Vergi ve harç oranlarında oluşabilecek değişiklikler fiyatlara aynen yansıtılır.

Özellikler modellere göre farklılık gösterebilir. Bu katalogdaki ürünlerle ilgili her türlü değişiklik yapma hakkı Boğaziçi İthalat Dış Tic. Paz. Ltd. Şti.'ne aittir. Katalogda oluşabilecek tipografik ve görsel hatalardan Boğaziçi İthalat Dış Tic. Paz. Ltd. Şti. sorumlu değildir.

**Boğaziçi**  
İthalat dış tic.  
paz. İtd. Şti.

**Merkez Ofis**  
Gayrettepe Mah. Yıldız Posta Cad.  
D Plaza No: 52 K: 6 D: 47  
34349 Beşiktaş - İstanbul  
Tel : 0.212 251 07 07 (pbx)  
Faks : 0.212 251 62 14  
e-mail: info@bogaziciithalat.com.tr  
www.bogaziciithalat.com.tr

**İstanbul Showroom**  
(Nispetiye On)  
Nispetiye Mah. Nispetiye Cad.  
No: 8-12/G İç kapı: 1 D: 99  
Etiler - Beşiktaş/İSTANBUL  
Tel: 0.212 288 11 22 (pbx)



Vale hizmeti verilmektedir.

**Ankara Showroom**  
(Beytepe 1923)  
Beytepe Mah. Kanuni Sultan Süleyman  
Bulvarı No: 50 1C/13  
Beytepe - Çankaya/ANKARA  
Tel: 0.312 503 11 99 (pbx)